

## Tilt-A-Wheel Cobra™

innovative one-hand dial-in tilt simplifies keyboard angle adjustments.....

## Classic Cobra™

a revolutionary ergonomic concept to reduce fatigue through quick and easy changes in working position.....

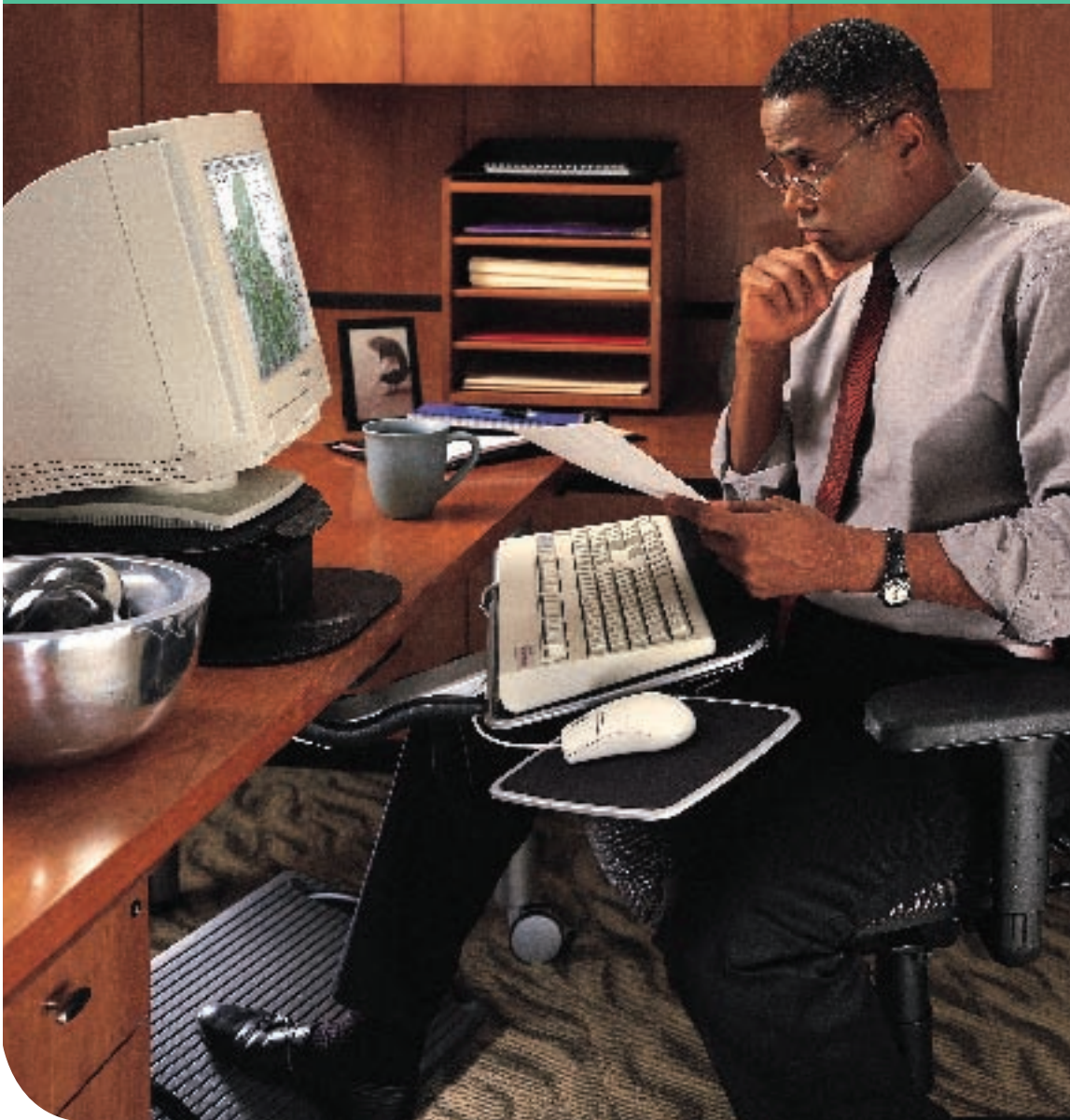

The stylized Cobra™ mechanisms put the keyboard and mouse in perfect user position throughout its impressive 12½" (317 mm) height adjustment range. The Cobra™ shines with its ability to position the keyboard closer to the edge of your worksurface, closer than any other keyboard arm on the market. The rigid box frame construction offers the user the most stable keyboard foundation anywhere. With our patented designs, trays and mousing options, it is easy to assemble a keyboarding system that offers maximum flexibility and a personalized ergonomic fit.

INNOVATIVE IDEAS IN WORKPLACE COMFORT



## Tilt-A-Wheel Cobra™ offers all of the advantages of the Classic Cobra™ plus:

- Convenient one-hand tilt adjustment by rotating the soft touch wheel

## Classic Cobra™ Advantages:

- With two models to choose from, the unique Cobra™ mechanisms offer a tremendous 12½" (317 mm) of travel to accommodate users of varying heights, in seated to sit to stand applications
- Provides greatest range of user mobility with a full 20° of negative tilt and 10° of positive tilt
- 360° rear swivel for optimal keyboard tray positioning
- More compact than other enhanced range arms on the market, the Cobra™ and platform will fully retract on a 23" (584 mm) track
- Slim profile allows for maximum knee clearance when in use or retracted.
- Box frame design provides maximum side-to-side keyboard tray stability for a solid, quality feel
- Available in durable black powder coat (standard), or with a choice of custom colors
- Installation hardware and instructions included
- Exceeds ANSI/BIFMA X5.5, 1998 industry performance standard
- Lifetime warranty

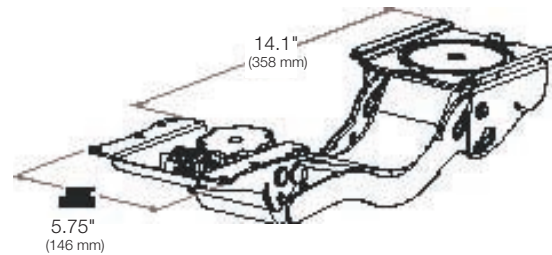

### Tilt-A-Wheel Cobra™ SPECIFICATIONS

HEIGHT ADJUSTMENT	
UP	7" (178 mm)
DOWN	5½" (140 mm)
TOTAL	12½" (318 mm)
HEIGHT SET	LIFT AND RELEASE
TILT	+10° / -20°
360° SWIVEL	YES
FULLY RETRACTABLE	YES, 23" (584 mm) TRACK INCLUDED
ANSI/BIFMA X5.5 1998	YES, EXCEEDS
MATERIAL	STEEL
FINISH	TEXTURED BLACK POWDER COAT

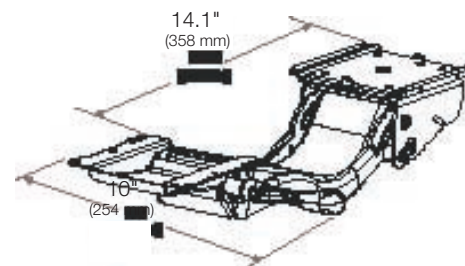

### Classic Cobra™ SPECIFICATIONS

HEIGHT ADJUSTMENT	
UP	7" (178 mm)
DOWN	5½" (140 mm)
TOTAL	12½" (318 mm)
HEIGHT SET	LIFT AND RELEASE
TILT	+10° / -20°
360° SWIVEL	YES
FULLY RETRACTABLE	YES, 23" (584 mm) TRACK INCLUDED
ANSI/BIFMA X5.5 1998	YES, EXCEEDS
MATERIAL	STEEL
FINISH	TEXTURED BLACK POWDER COAT

### TRACK OPTIONS

#### Tilt-A-Wheel Cobra™ dial-in tilt

18" Track	<b>KCO18</b>
21" Track	<b>KCO21</b>
23" Track	<b>KCO23</b>

#### Classic Cobra™ wand tilt

Track Size	Model #
18" Track	<b>KCO18W</b>
21" Track	<b>KCO21W</b>
23" Track	<b>KCO23W</b>

#### Cobra™ wheel tilt with roller track

Track Size	Model #
23" Track	<b>KCO23R</b>

#### Classic Cobra™ dual swivel wand tilt

Track Size	Model #
23" Track	<b>KCO23WDS</b>



- STANDARD 23" (584 mm) GLIDE TRACK PROVIDES COMPLETE RETRACTABILITY
- NON-STANDARD TRACK LENGTHS ARE AVAILABLE UPON REQUEST



- 23" (584 mm) SLIMMOUNT™ HORIZONTAL BALL-BEARING SLIDE TRACK
- PLACE -BB AFTER THE PART NUMBER ON YOUR ORDER



- 23" (584 mm) ROLLER TRACK FEATURES KEYHOLE SLOTS FOR EASY INSTALLATION

### NEGATIVE-TILT ONLY

- AVAILABLE WITH ALL COBRA™ TRAY SETS, THE ARTICULATING ARM COMES PRESET AT THE FACTORY TO OPERATE IN ONLY THE NEGATIVE-TILT POSITION.
- **TO ORDER:** PLACE -NTO AFTER THE PART NUMBER ON YOUR ORDER



Combine any Cobra™ model with a SecureFit™ clamp for the perfect combo:

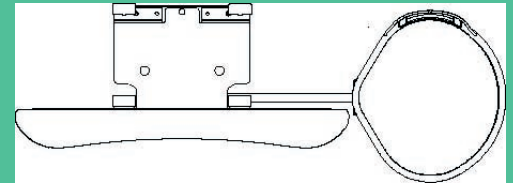

MOUSE SURFACE TILTS AND SWIVELS  
ADJUSTS IN AND OUT  
AND SWITCHES FROM SIDE TO SIDE FOR L.H. AND R.H.

- Ultra small footprint, actual size of the keyboard is all that is needed
- Mouse can be adjusted: left/right, width to eliminate any need for user reach, pivot for precise mouse positioning all without tools
- Positive fit for keyboard, stability without lateral movement
- Slow recovery foam palm rest
- Low profile design

### Dual-Swivel Cobra™ Advantages:

- Allows for lateral mobility across the front edge of the work surface for in-line positioning, correcting for installer error and for glare conditions at varying times during the day
- Due to the integrated design, tilt settings remain constant throughout all swivel ranges
- Will work in virtually all applications including 90 degree corners
- Does not effect the ability of the arm to fully retract on a standard track

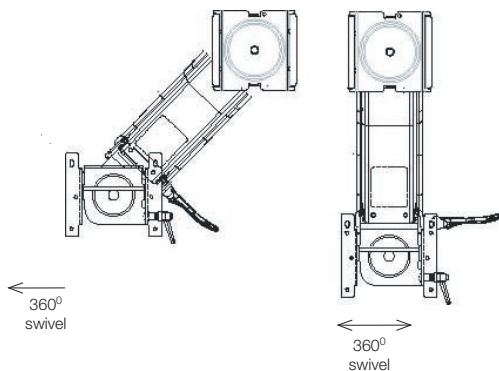

### DUAL-SWIVEL CLASSIC COBRA™ SPECIFICATIONS

HEIGHT ADJUSTMENT	
UP	7" (178 mm)
DOWN	5½" (140 mm)
TOTAL	12½" (318 mm)
HEIGHT SET	LIFT AND RELEASE
TILT	+10° / -20°
360° SWIVEL	YES
FULLY RETRACTABLE	YES, 23" (584 mm) TRACK INCLUDED
ANSI/BIFMA X5.5 1998	YES, EXCEEDS
MATERIAL	STEEL
FINISH	TEXTURED BLACK POWDER COAT

### dual swivel plate 25396

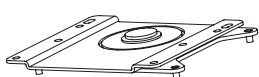

- fits straight, diagonals 12" (304 mm) and greater, radius 12" (304 mm)
- denoted as DS suffix in combos
- for full tilt range throughout all swivel positions specify KCO23DS (Classic Cobra with integrated dual swivel functionality)

## CobraMate™ Advantages:

- Ultimate in stability
- Two widths available, 22" (558 mm) and 30" (762 mm)
- Height adjustment through an impressive 12½" (318 mm) travel range controlled with a "Lift and Release" design
- Retracts 8½" (215 mm) to optimize position of the workspace
- Flexible design enables product to be retrofitted to existing furniture
- Spring balanced for effortless height adjustment
- Mounts below the primary work surface
- Slim profile allows for maximum knee clearance
- Exceeds the ANSI/BIFMA X5.5 1998 industry performance standards for wide keyboard surfaces
- Lifetime warranty

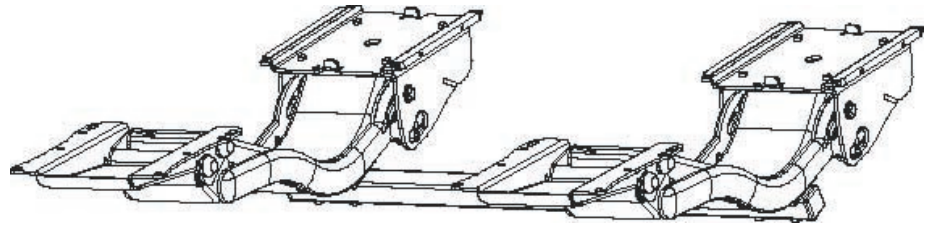

### CobraMate™ SPECIFICATIONS

HEIGHT ADJUSTMENT	12½" (318 mm)
WIDTHS	22" (558 mm) OR 30" (762 mm)
RETRACTS	8½" (215 mm)
ANSI/BIFMA X5.5 1998	YES, EXCEEDS FOR WIDE KEYBOARD SURFACES
MATERIAL	STEEL
FINISH	TEXTURED BLACK POWDER COAT

